

5000 Series FLOOR ACCESS COVERS

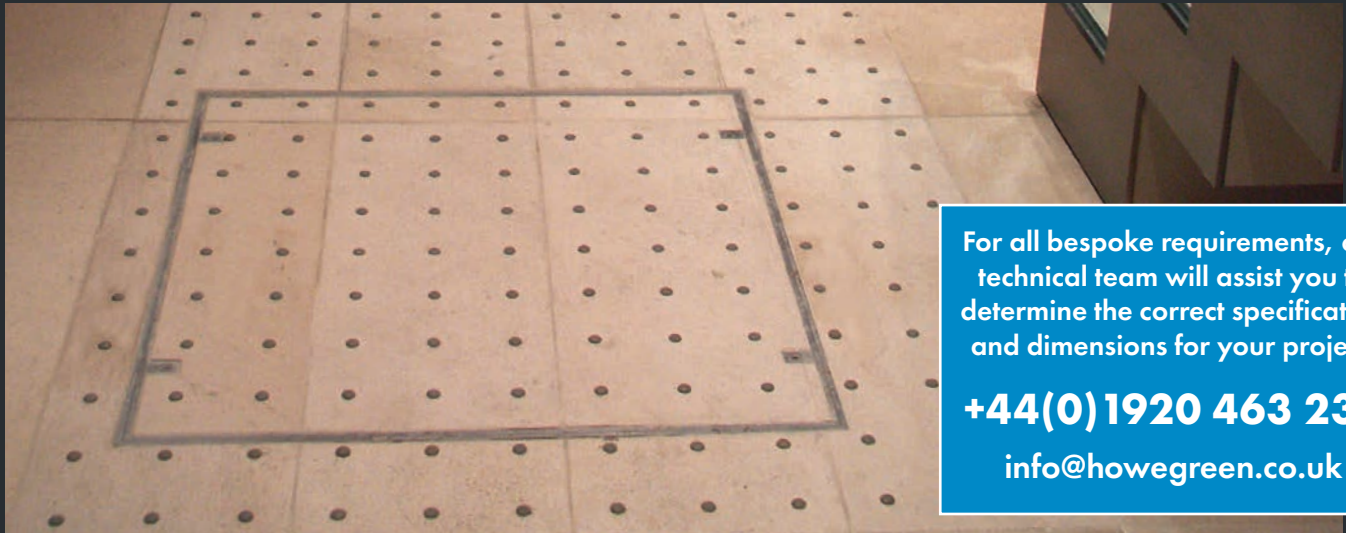

For all bespoke requirements, our technical team will assist you to determine the correct specification and dimensions for your project.

+44(0)1920 463 230

info@howegreen.co.uk

Aluminium, recessed floor access covers for hard finishes, available as single, duct or multipart

» FEATURES

- Covers can be fitted quickly and unobtrusively into all types of hard floor finish: ceramic tiles, marble, terrazzo, resin or parquet
- Unique patented cover sections are tapered for easy removal, and frame sections give a good key to bedding mortar. Covers are precision-made to avoid distortion
- Top edge seal on aluminium covers helps prevent dirt, grout or grinding waste penetrating joint between cover and frame
- Double seals are available
- Lifting blocks are anchored to the inner frame. Stainless steel securing bolts are stiletto heel proof
- Optional brass, stainless steel or coloured high impact pvc show edge on aluminium 5000 series is continuously secured; there are no fasteners to rust or break
- Manufactured in the UK to BS EN ISO 9001:2015

» 5000 SERIES FLOOR ACCESS COVERS

Size

- Made to measure using the Howe Green patented system
- Manufactured in any size between the stated maximum and minimum dimensions
- Any configuration of ducts and branches can be created

Weight

- The weight of the access cover should be taken into account where ease of handling is an important consideration
- In all cases reference should be made to the Manual Handling Operations regulations 1992, which implement European Directive 90/269/EEC
- If loads are excessive, consideration should be given to the use of hydraulic lifters or our **HSE 75 range**

Where large covers are necessary, for example over pits containing plant, the main covers can be fitted with small inset covers to allow easy access for routine maintenance. The main covers need then only be removed for major overhauls or plant replacement.

5000 Series ALUMINIUM SINGLE COVER

» FLOOR ACCESS COVERS FOR PEDESTRIAN TRAFFIC

Typical floor finishes

- Ceramic tiles, marble, terrazzo, concrete, resin, wood and all hard floors

Performance

- Interior and exterior solid floors
- Pedestrian traffic (including wheeled trolleys, sack trucks etc.) only
- Performance is subject to correct infill and installation
- More information can be found at www.howegreen.com

Options

- Every cover is available with a choice of aluminium or brass show edge, and matching lifting blocks
- Coloured high impact pvc edges are available in a range of seven colours with aluminium lifting blocks. See www.howegreen.com for more information
- Double seal or top edge seal
- Stainless steel or steel baseplate and reinforcement

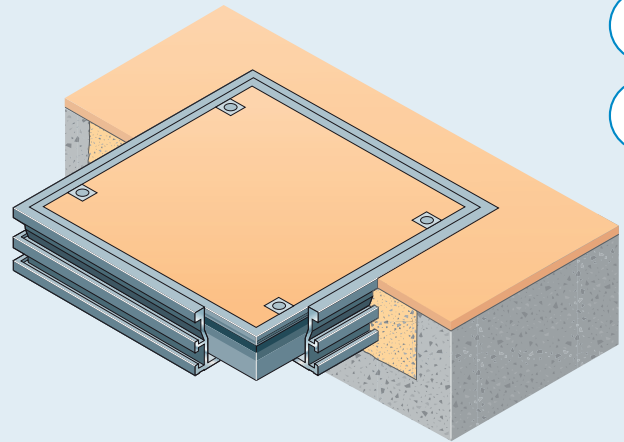

Cross section showing concrete and timber sub-floors (scale 1:2)

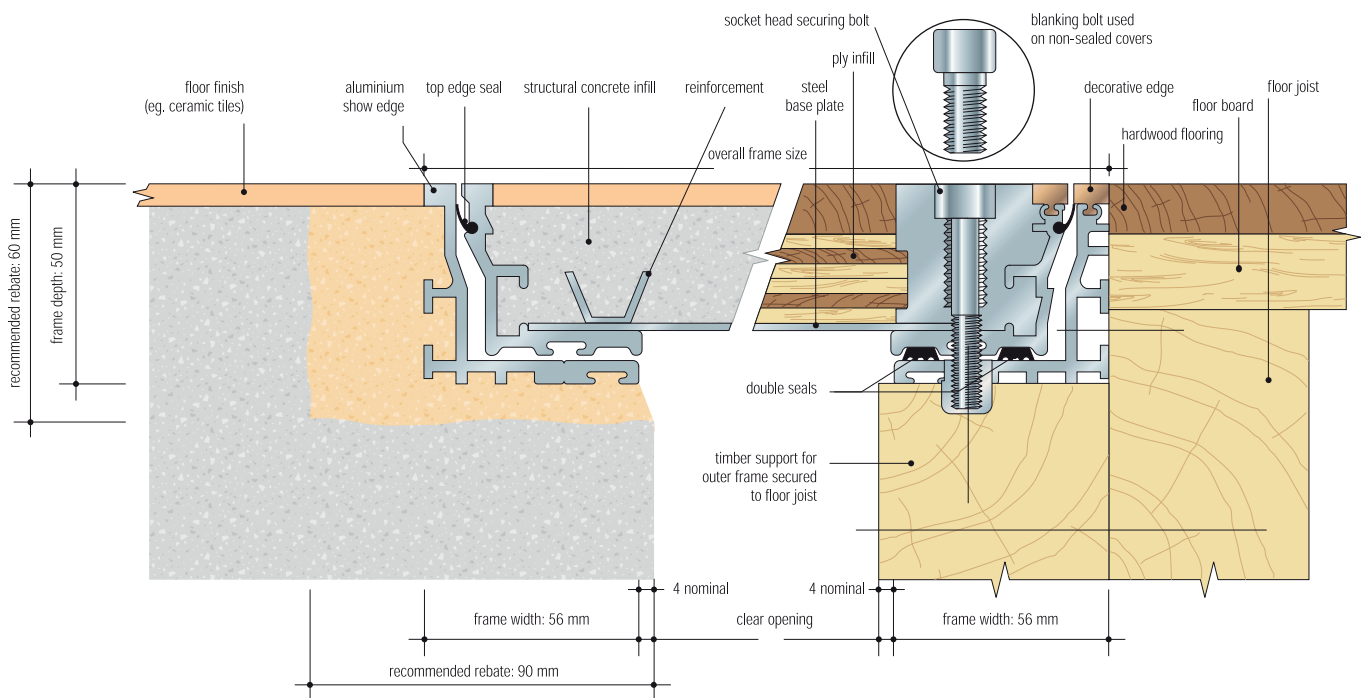

Size

- Overall frame size = clear opening + 120 mm
- Clear opening:
Single: 150 min – 750 mm max,
Duct: 100 min – 600 mm max,
Multipart: Please contact us
- Frame depth 50 mm
- Lifting points : inset as standard

Weight

- A 5000 series aluminium cover when filled with concrete weighs approximately 90kg/m²

Maximum / minimum sizes

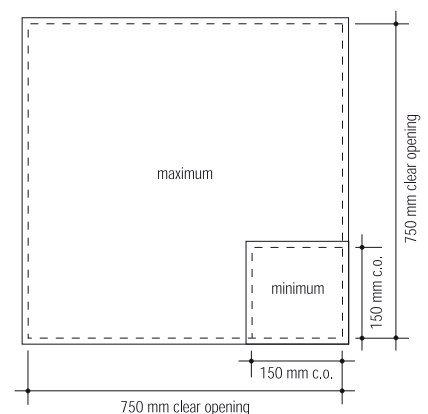

5000 Series ALUMINIUM DUCT COVER

» FLOOR ACCESS COVERS FOR PEDESTRIAN TRAFFIC

Typical floor finishes

- Ceramic tiles, marble, terrazzo, concrete, resin, wood and all hard floors

Performance

- Interior and exterior solid floors
- Pedestrian traffic (including wheeled trolleys, sack trucks etc.) only
- Performance is subject to correct infill and installation
- More information can be found at www.howegreen.com

Options

- Every cover is available with a choice of aluminium or brass show edge, and matching lifting blocks
- Coloured high impact pvc edges are available in a range of seven colours with aluminium lifting blocks. See www.howegreen.com for more information
- Double seal or top edge seal
- Stainless steel or steel baseplate and reinforcement

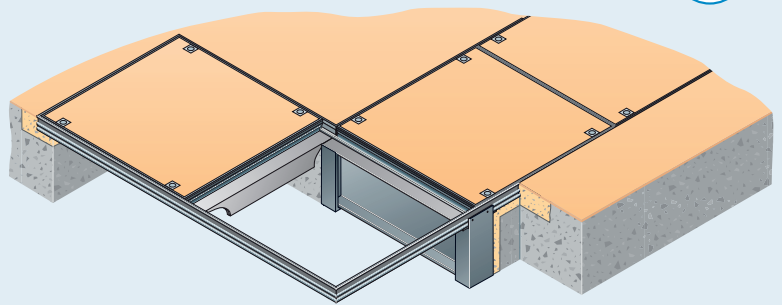

Cross section showing anchor lugs and locking/lifting detail (scale 1:2)

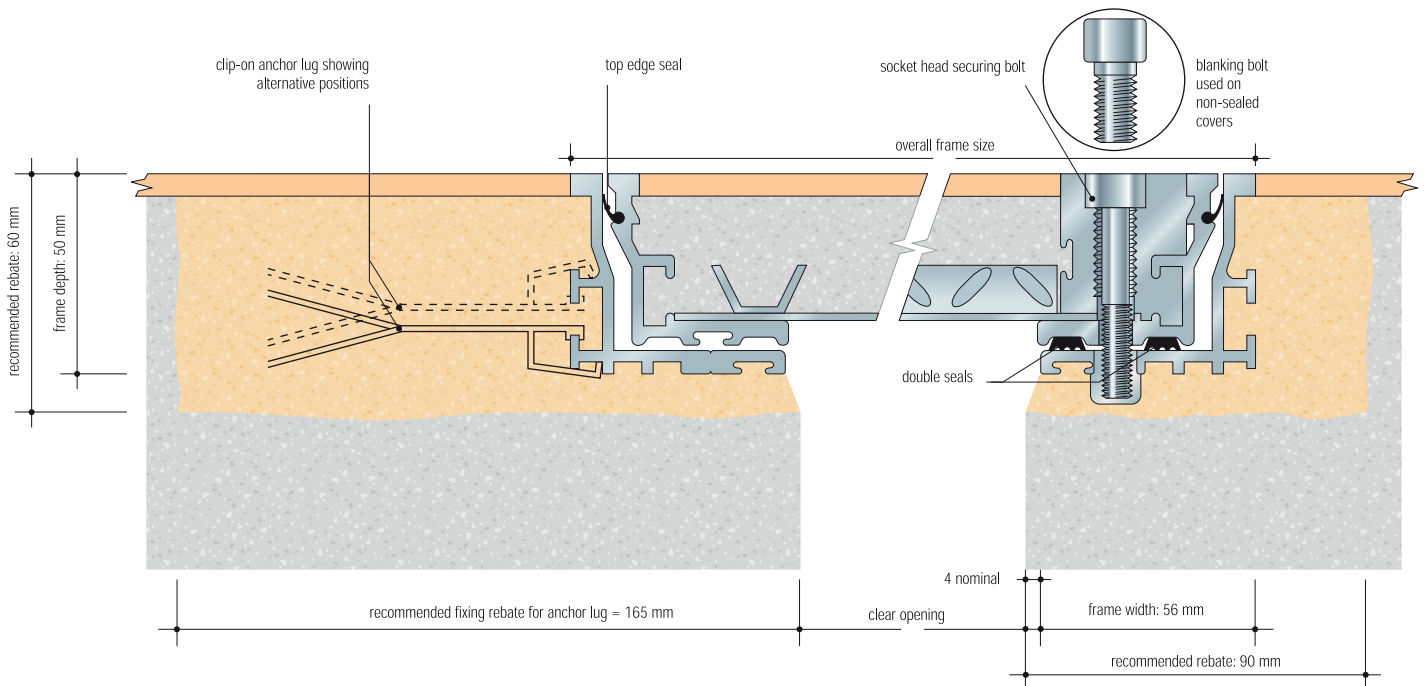

Size

- Overall frame size = clear opening + 120 mm
- Clear opening:
Single: 150 min – 750 mm max,
Duct: 100 min – 600 mm max,
Multipart: Please contact us
- Frame depth 50 mm
- Lifting points : inset as standard

Weight

- A 5000 series aluminium cover when filled with concrete weighs approximately 90kg/m²

Typical layout

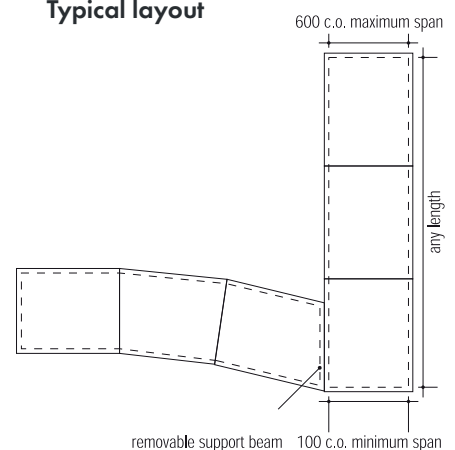

5000 Series ALUMINIUM MULTIPART COVER

» FLOOR ACCESS COVERS FOR PEDESTRIAN TRAFFIC

Typical floor finishes

- Ceramic tiles, marble, terrazzo, concrete, resin, wood and all hard floors

Performance

- Interior and exterior solid floors
- Pedestrian traffic (including wheeled trolleys, sack trucks etc.) only
- Performance is subject to correct infill and installation
- More information can be found at www.howegreen.com

Options

- Every cover is available with a choice of aluminium or brass show edge, and matching lifting blocks
- Coloured high impact pvc edges are available in a range of seven colours with aluminium lifting blocks. See www.howegreen.com for more information
- Double seal or top edge seal
- Stainless steel or steel baseplate and reinforcement

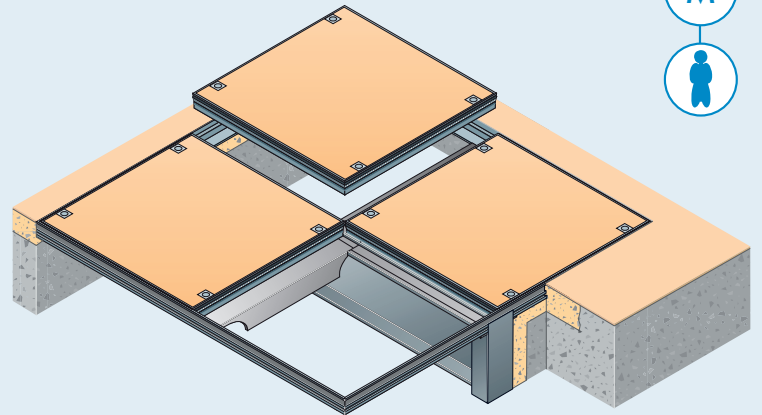

Cross section showing removable support beam and cross members (scale 1:5)

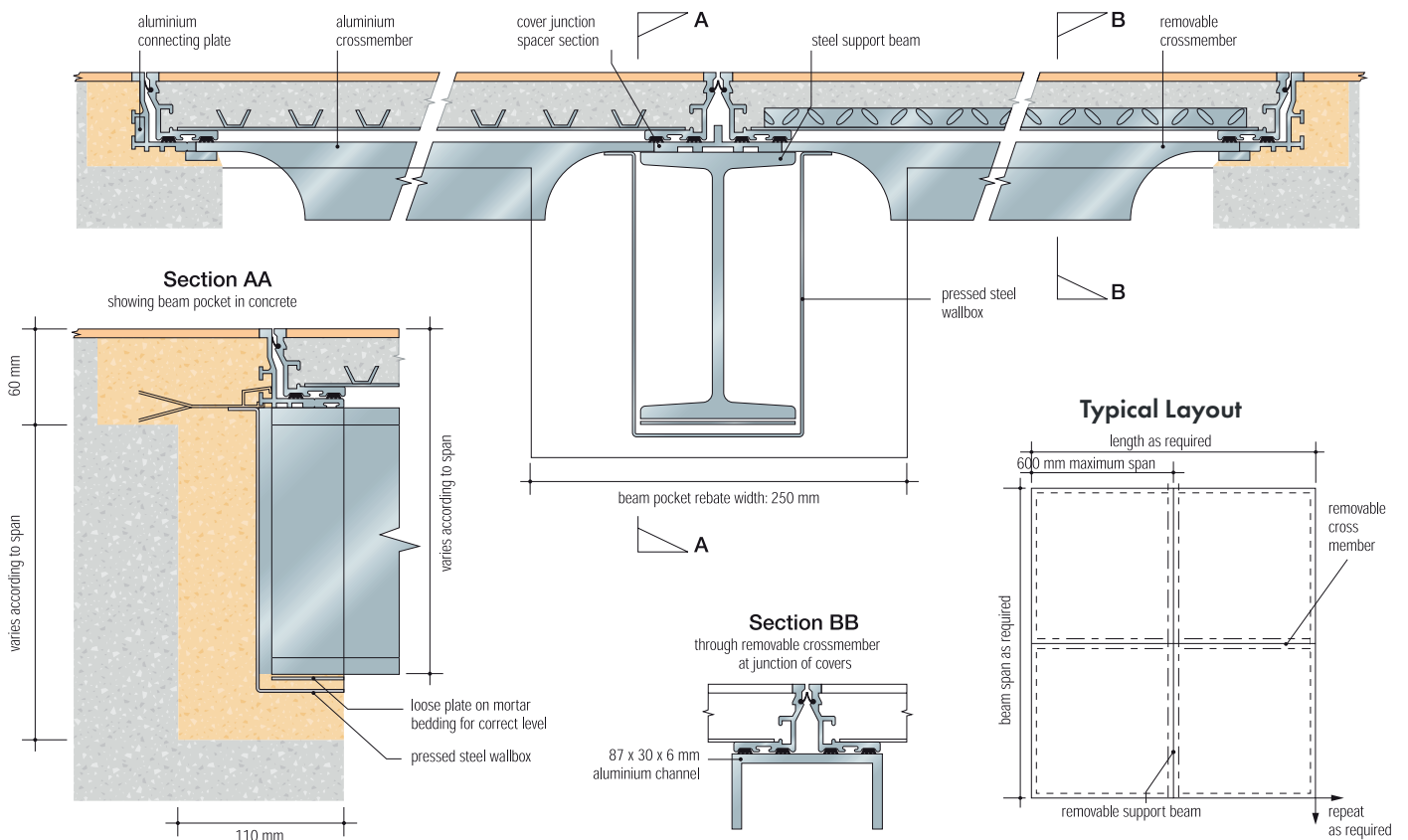

» CONTACT US

Sales Enquiries

+44(0)1920 463 230 info@howegreen.co.uk www.howegreen.com

Innovation drive, Wolverhampton, West Midlands, WV9 5GA, UK

